



**apparecchio di illuminazione da parete e picchetto per interni ed esterni IP65. realizzato in alluminio ossidato e verniciato a polvere, composto da una testa cilindrica di diametro Ø80mm h.126mm orientabile di 360° lungo l'asse verticale e 90° lungo l'asse orizzontale.**

**modelli:**

**p2 parete soffitto diametro Ø80mm,**

**p2 parete soffitto con scatola contenente alimentatore 240V 50-60Hz incluso,**

**p2 picchetto con asta diametro Ø20mm h.45mm fuori terra,**

**p2 picchetto con asta diametro Ø20mm h.830mm fuori terra.**

**cablato con sorgente elettronica 3000K fino a 24,2W 3033lm.**

**ottiche: 22°**

**alimentatore in corrente costante escluso, da installare remoto.**

**finiture: bruno antico, nero notte, scurodivals e grigio argento.**

**IP65 rated wall and stake light fitting for indoor and outdoor use. made of powder coated and oxidised aluminium, consisting of diameter Ø80mm h.126mm cylindrical head adjustable by 360° on the vertical axis and by 90° on the horizontal axis.**

**versions:**

**p2 parete soffitto for wall and ceiling mounting with diameter Ø80mm,**

**p2 parete soffitto for wall and ceiling mounting with a box containing the 240V 50-60Hz power supply included,**

**p2 picchetto stake with a diameter Ø20mm rod h.45mm above the ground,**

**p2 picchetto stake with a diameter Ø20mm rod h.830mm above the ground.**

**wired with 3000K led source up to 24.2W 3033lm.**

**optics: 22°**

**constant current power supply not included, to be installed remotely.**

**finishes: antique brown, night black, scurodivals and silver grey.**



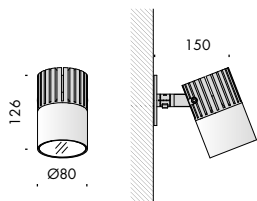

p2 parete soffitto			IP65	☆	CE	i
<b>Vb6.565.01</b>	bruno antico · antique brown	3000K	22°	0,9		
<b>Vb6.565.03</b>	nero notte · night black	3000K	22°	0,9		
<b>Vb6.565.05</b>	scurodivals	3000K	22°	0,9		
<b>Vb6.565.07</b>	grigio argento · silver grey	3000K	22°	0,9		

Ra	ies tm-30		sdc	mA	V <sub>f</sub> (min)	lm	W	lm/W	
90	Rf 90	Rg 100	step 2	350	30,1	1630	11,3	144	<b>A++</b>
				500	31,0	2255	16,7	135	<b>A++</b>
				700	32,1	3033	24,2	125	<b>A++</b>
tm011	les19	☉	Ta25 °C	vita media · average life	50000 h	L70	B10		

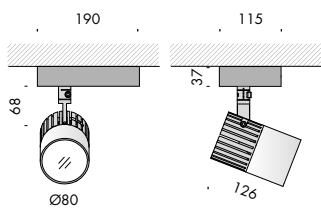
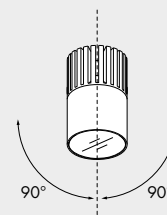
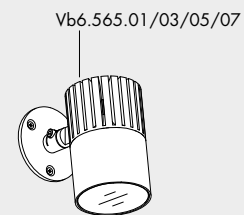





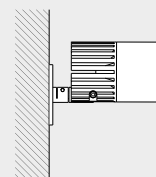
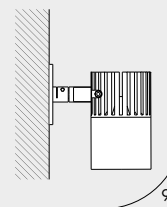

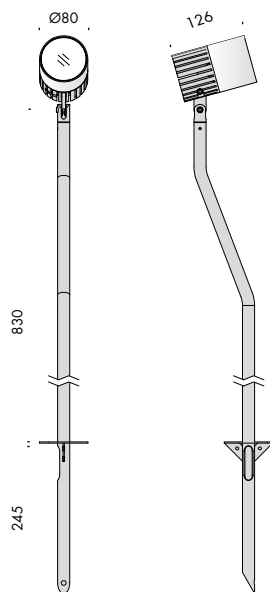
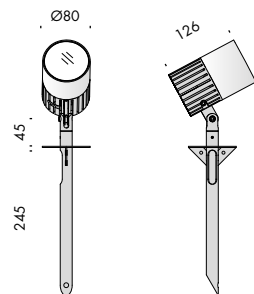
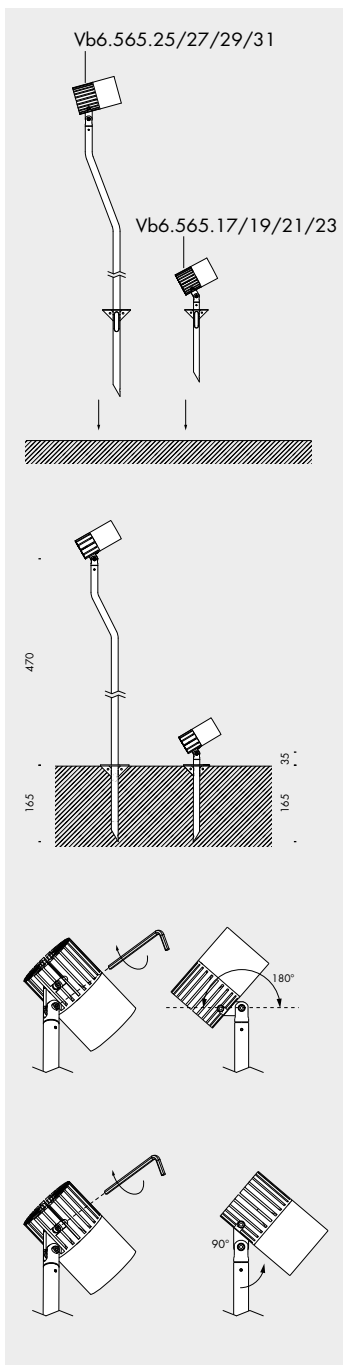
p2 parete soffitto		240V 50-60Hz	A	IP65	☆	CE	i
<b>Vb6.565.09</b>	bruno antico · antique brown	3000K	22°	1			
<b>Vb6.565.11</b>	nero notte · night black	3000K	22°	1			
<b>Vb6.565.13</b>	scurodivals	3000K	22°	1			
<b>Vb6.565.15</b>	grigio argento · silver grey	3000K	22°	1			



Ra	ies tm-30		sdc	mA	V <sub>f</sub> (min)	lm	W	lm/W	
90	Rf 90	Rg 100	step 2	700	32,1	3033	24,2	125	<b>A++</b>
tm011	les19	☉	Ta25 °C	vita media · average life	50000 h	L70	B10		













**p2 picchetto 45**   IP65    

<b>Vb6.565.17</b>	bruno antico · antique brown	3000K	22°	1,4
<b>Vb6.565.19</b>	nero notte · night black	3000K	22°	1,4
<b>Vb6.565.21</b>	scurodivals	3000K	22°	1,4
<b>Vb6.565.23</b>	grigio argento · silver grey	3000K	22°	1,4

Ra	ies tm-30		sdc	mA	V <sub>f</sub> (min)	lm	W	lm/W	
90	Rf 90	Rg 100	step 2	350	30,1	1630	11,3	144	<b>A++</b>
				500	31,0	2255	16,7	135	<b>A++</b>
				700	32,1	3033	24,2	125	<b>A++</b>
tm011	les19 	Ta25 °C	vita media · average life	50000 h	L70 B10				

**p2 picchetto 830**   IP65    

<b>Vb6.565.25</b>	bruno antico · antique brown	3000K	22°	2,2
<b>Vb6.565.27</b>	nero notte · night black	3000K	22°	2,2
<b>Vb6.565.29</b>	scurodivals	3000K	22°	2,2
<b>Vb6.565.31</b>	grigio argento · silver grey	3000K	22°	2,2

Ra	ies tm-30		sdc	mA	V <sub>f</sub> (min)	lm	W	lm/W	
90	Rf 90	Rg 100	step 2	350	30,1	1630	11,3	144	<b>A++</b>
				500	31,0	2255	16,7	135	<b>A++</b>
				700	32,1	3033	24,2	125	<b>A++</b>
tm011	les19 	Ta25 °C	vita media · average life	50000 h	L70 B10				



cavi con connettore femmina m8. cables with m8 female connector. IP67 ☆ CE ï		
<b>f9.250.70</b>	150mm	0,01
<b>f9.164.86</b>	2000mm	0,1
<b>f9.164.87</b>	5000mm	0,2
<b>f9.164.88</b>	10000mm	0,3



cavi con connettori m/f m8. cables with m8 m/f connectors. IP67 ☆ CE ï		
<b>f9.250.72</b>	2000mm	0,1
<b>f9.250.73</b>	5000mm	0,3
<b>f9.250.74</b>	10000mm	0,6

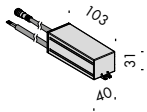

alimentatori. power supplies. 240V 50-60Hz A IP67 CE ï				
<b>t4.411</b>	15W	350mA	0,2	

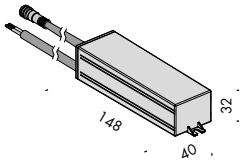

<b>t4.421</b>	25W	500mA	0,2	
---------------	-----	-------	-----	--

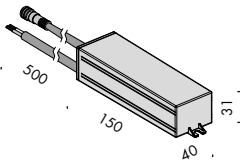

<b>t4.413</b>	30W	700mA	0,2	
---------------	-----	-------	-----	--



Subscribe To Our Newsletter



**Distributor for Viabizzuno  
Architectural Lighting Solutions**

Web: [www.cirruslighting.co.uk](http://www.cirruslighting.co.uk)

Email: [sales@cirruslighting.co.uk](mailto:sales@cirruslighting.co.uk)

Tel: 0207 193 2175

Fax: 0207 193 3175

