



apparecchio di illuminazione da parete o soffitto e picchetto per interni ed esterni IP65. realizzato in alluminio ossidato e verniciato a polvere composto da una testa cilindrica di diametro Ø36mm h. 73mm orientabile di 360° lungo l'asse verticale e 90° lungo l'asse orizzontale.

modelli:

*p1 parete diametro Ø36mm,
p1 picchetto 35 con asta diametro Ø12mm h.35mm fuori terra,
p1 picchetto 470 con asta diametro Ø12mm h.470 mm fuori terra.
cablato con sorgente elettronica 3000K Ra95 fino a 6,8W 493lm.
ottiche: 32°
alimentatore in corrente costante escluso da installare remoto.
finiture: bruno antico, nero notte, scurodivals e grigio argento.*



IP65 rated wall or ceiling and stake light fitting for indoor and outdoor use.

made of powder oxidised and painted aluminium, consisting of diameter Ø36mm h.73mm cylindrical head adjustable by 360° on the vertical axis and by 90° on the horizontal axis.

versions:

p1 parete for wall mounting with a diameter Ø36m,

p1 picchetto 35 with a diameter Ø12mm rod h.35mm above the ground,

p1 picchetto 470 with a diameter Ø12mm rod h.470mm above the ground.

wired with 3000K Ra95 led source up to 6.8W 493lm.

optics: 32°



constant current power supply not included, to be installed remotely. finishes: antique brown, night black, scurodivals and silver grey.

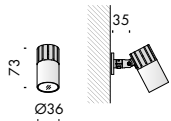



p1 parete   **IP65**   **CE** 

Vb6.566.01	bruno antico · antique brown	3000K	32°	0,3
Vb6.566.03	nero notte · night black	3000K	32°	0,3
Vb6.566.05	scurodivals	3000K	32°	0,3
Vb6.566.07	grigio argento · silver grey	3000K	32°	0,3

Ra	ies tm-30		sdc	mA	V _f (min)	lm	W	lm/W	
95	Rf 92	Rg 100	step 2	500	9,2	384	4,5	85	A+
				700	9,7	493	6,8	73	A+
cd021	lesó 	Ta25 °C	vita media · average life	50000 h		L80	B10		

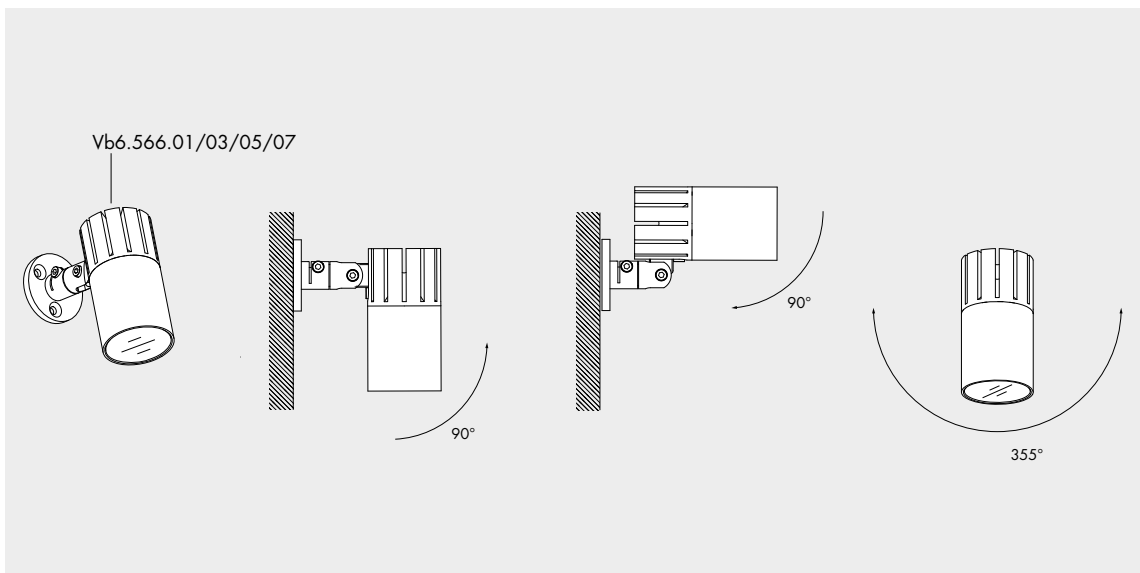

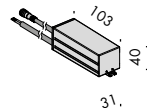
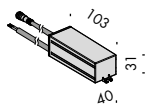
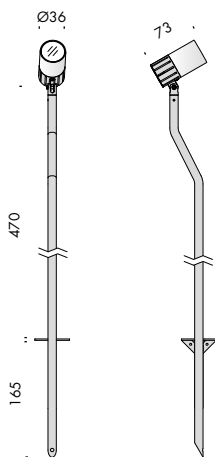
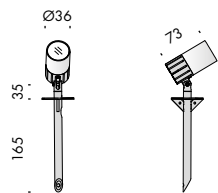
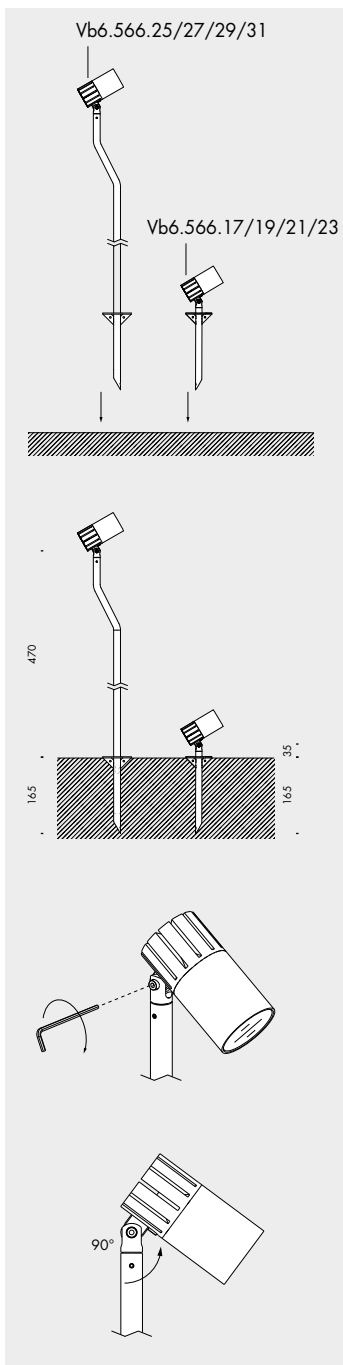

p1 picchetto 35							
Vb6.566.17	bruno antico · antique brown	3000K	32°	0,4			
Vb6.566.19	nero notte · night black	3000K	32°	0,4			
Vb6.566.21	scurodivals	3000K	32°	0,4			
Vb6.566.23	grigio argento · silver grey	3000K	32°	0,4			

Ra	ies tm-30		sdc	mA	V _{f (min)}	lm	W	lm/W	
95	Rf 92	Rg 100	step 2	500	9,2	384	4,5	85	A+
				700	9,7	493	6,8	73	A+
cd021	les6	Ta25 °C	vita media · average life	50000 h	L80	B10			

p1 picchetto 470							
Vb6.566.25	bruno antico · antique brown	3000K	32°	0,9			
Vb6.566.27	nero notte · night black	3000K	32°	0,9			
Vb6.566.29	scurodivals	3000K	32°	0,9			
Vb6.566.31	grigio argento · silver grey	3000K	32°	0,9			

Ra	ies tm-30		sdc	mA	V _{f (min)}	lm	W	lm/W	
95	Rf 92	Rg 100	step 2	500	9,2	384	4,5	85	A+
				700	9,7	493	6,8	73	A+
cd021	les6	Ta25 °C	vita media · average life	50000 h	L80	B10			

alimentatori. power supplies.		240V 50-60Hz				
t4.412		18W	500mA	0,2		
t4.419		18W	700mA	0,2		



cavi con connettore femmina m8. cables with m8 female connector. IP67 ☆ C€ i

f9.250.70	150mm	0,01
f9.164.86	2000mm	0,1
f9.164.87	5000mm	0,2
f9.164.88	10000mm	0,3



cavi con connettori m/f m8. cables with m8 m/f connectors. IP67 ☆ C€ i

f9.250.72	2000mm	0,1
f9.250.73	5000mm	0,3
f9.250.74	10000mm	0,6





Subscribe To Our Newsletter



**Distributor for Viabizzuno
Architectural Lighting Solutions**

Web: www.cirruslighting.co.uk

Email: sales@cirruslighting.co.uk

Tel: 0207 193 2175

Fax: 0207 193 3175

