

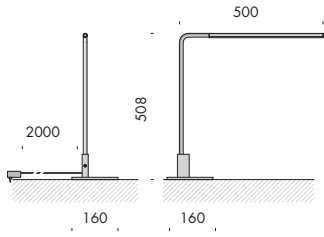

**corpo illuminante da tavolo per interni IP20.
realizzato con profilo di alluminio estruso Ø13mm ossidato e verniciato a polvere.
composto da una base quadrata in acciaio 160x160x5mm, da un supporto rettangolare
che contiene l'interruttore touch on/off e una porta usb su cui è innestato il profilo tubolare.
dimensioni 500x508x160mm.
orientabile di 300° sull'asse orizzontale e di 300° sull'asse verticale.
cablato con modulo led lineare e limitatore di corrente integrato 3000K 7W 432lm,
completo diffusore estruso in policarbonato sabbato.
alimentatore 100-240V 50-60Hz a spina e cavo di alimentazione l.2000mm incluso.
finiture: verniciato bianco o nero55.**

**IP20-rated table lamp for indoor use,
made of an extruded aluminium profile having a diameter of 13mm,
which is oxidised and powder painted.
composed of a steel square base measuring 160x160x5mm,
a rectangular support containing the on/off touch switch
and a usb port on which the tubular profile is fitted.
size: 500x508x160mm.
it can be adjusted by 300° on the horizontal axis and by 300° on the vertical axis.
wired with a linear led module and an integrated 3000K 7W 432lm current limiter,
equipped with extruded frosted polycarbonate diffuser.
100-240V 50-60Hz power supply unit with plug and 2000mm long power cable included.
finish: white or nero 55painted.**





la villa dx 220-240V 50-60Hz **A** IP20 **CE**

Vb2.582.01 bianco V led 3000K 7W

Vb2.582.02 nero55 led 3000K 7W

Ra	selezione macadam macadam selection	lm	W	lm/W	classe energetica energy class
95	step 2	670	7	96	A+

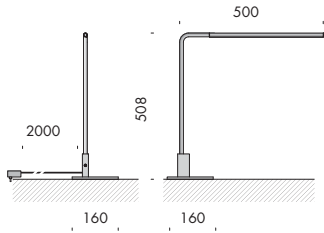

la villa sx 220-240V 50-60Hz **A** IP20 **CE**

Vb2.582.03 bianco V led 3000K 7W

Vb2.582.04 nero55 led 3000K 7W

Ra	selezione macadam macadam selection	lm	W	lm/W	classe energetica energy class
95	step 2	670	7	96	A+

esempio di utilizzo
example of use

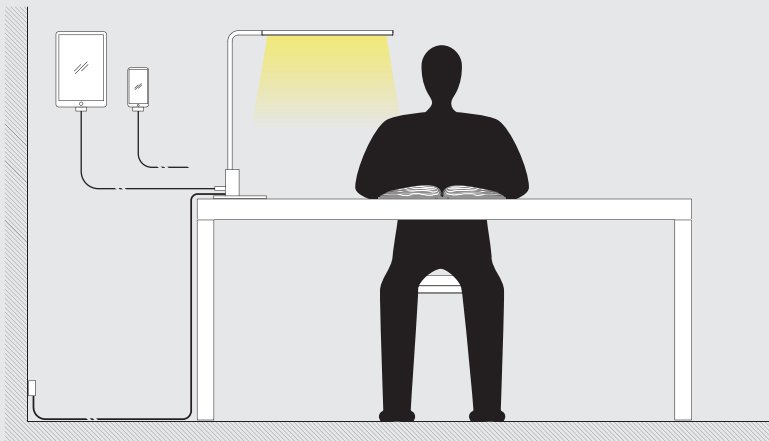

orientabilità
adjustability

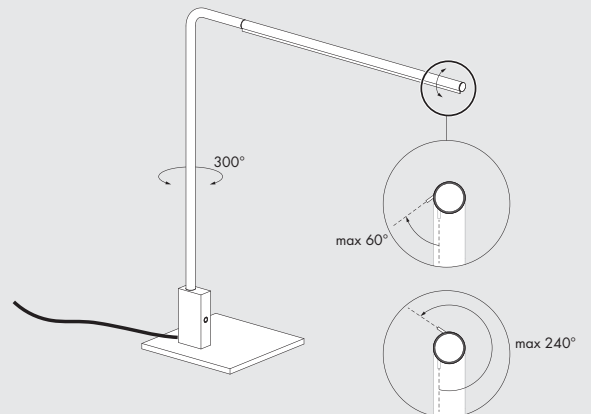



esempio di utilizzo
example of use

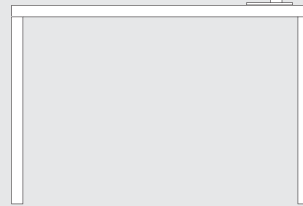
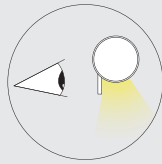
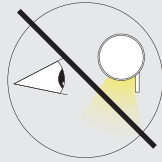

luce sinistra
left light

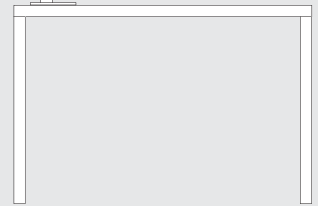
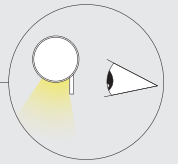
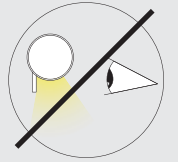

luce destra
right light

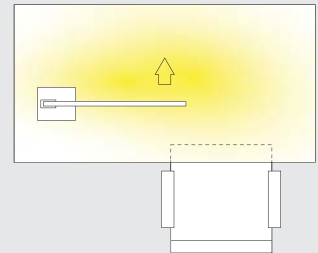
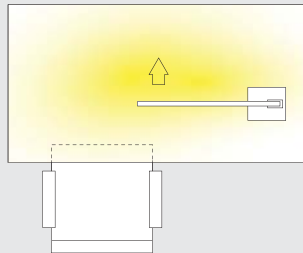



**Distributor for Viabizzuno
Architectural Lighting Solutions**

Web: www.cirruslighting.co.uk

Email: sales@cirruslighting.co.uk

Tel: 0207 193 2175

Fax: 0207 193 3175

