



apparecchio di illuminazione da terra per esterni costituito da un diffusore realizzato in vetroresina fissato ad un palo in acciaio verniciato a polvere, da ancorare ad apposito tirafondo in acciaio h.535mm.

modelli:

maxxi poppy 01 con sezione ellittica 1800x2050mm, altezza fuori terra di 4350mm, cablato per lampada ad alogenuri G12 fino a 150W con grado di protezione IP55, maxxi poppy 02 con sezione ellittica 1610x1590mm, altezza 3930mm fuori terra, cablato per lampada ad alogenuri G12 fino a 150W con grado di protezione IP55, poppy 03 con sezione ellittica 840x760mm, altezza 2040mm fuori terra, cablato per lampada ad alogenuri G12 fino a 70W con grado di protezione IP65. alimentatore 240V 50Hz escluso da installare in apposito pozzetto di derivazione. finiture: vetroresina rossa, palo bruno antico.

floor standing light fitting for outdoor use made of a fibreglass diffuser fitted to a powder coated steel pole, to be fixed to a special 535mm high steel ground anchor.

versions:

maxxi poppy 01 with 1800x2050mm elliptical section, a height of 4350mm above ground, wired for G12 metal halide lamp up to 150W, IP55 rated, maxxi poppy 02 with 1610x1590mm elliptical section, a height of 3930mm above ground, wired for G12 metal halide lamp up to 150W, IP55 rated, poppy 03 with 840x760mm elliptical section, a height of 2040mm above ground, wired for G12 metal halide lamp up to 70W, IP65 rated. 240V 50Hz power supply not included, to be installed in a special cable draw pit. finishes: red fibreglass, antique brown pole.

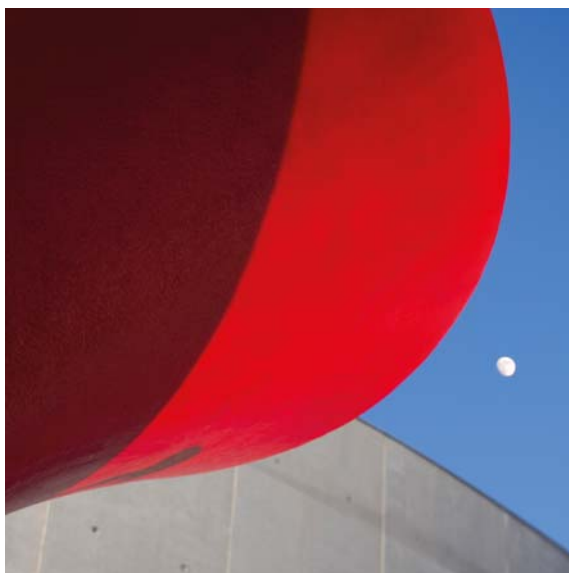

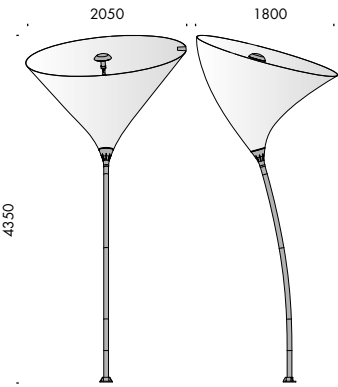



maxxi poppy 01   IP55  

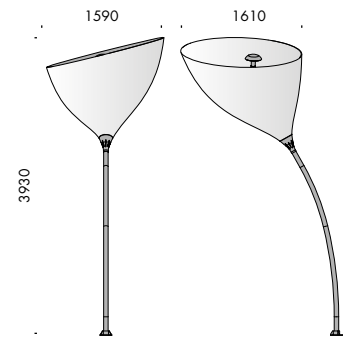

α4.531.01 vetroresina rossa · red fiberglass G12 35/70/150W 70

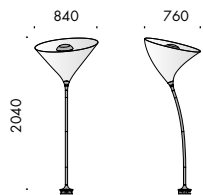

maxxi poppy 02   IP55  

α4.531.02 vetroresina rossa · red fiberglass G12 35/70/150W 70



poppy 03   IP65  

α4.531.11 vetroresina rossa · red fiberglass G12 35/70W 57



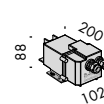
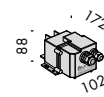
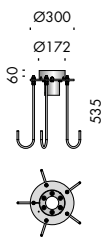
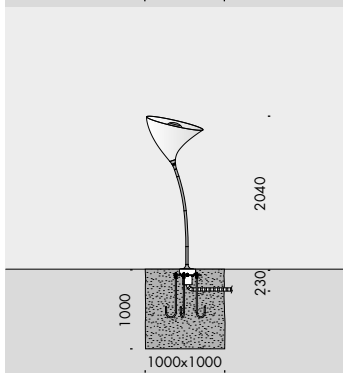
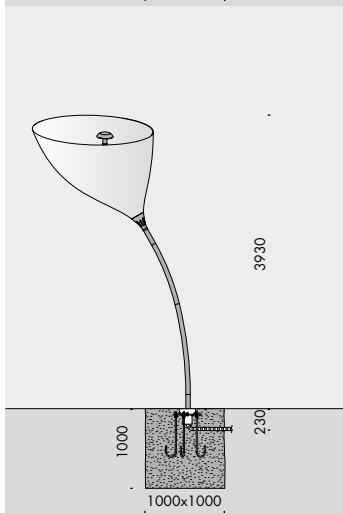
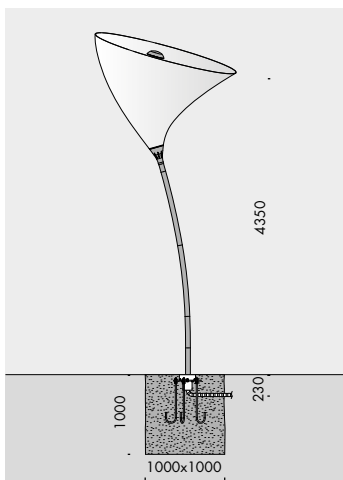

componenti. components. CE ⓘ

f9.211.91 tirafondo · anchor bolt 10

alimentatori. power supplies. 240V 50Hz Ⓜ □ IP67 CCG CE ⓘ

t5.055 35W 1,3

t5.057 70W 1,5

t5.059 150W 2,3





Subscribe To Our Newsletter



**Distributor for Viabizzuno
Architectural Lighting Solutions**

Web: www.cirruslighting.co.uk

Email: sales@cirruslighting.co.uk

Tel: 0207 193 2175

Fax: 0207 193 3175

